

Related topics

Seebeck effect (thermoelectric effect), thermoelectric e.m.f., efficiency, Peltier coefficient, Thomson coefficient, Seebeck coefficient, direct energy conversion, Thomson equations.

Principle and task

In a semi-conductor thermogenerator, the no-load voltage and the short-circuit current are measured as a function of the temperature difference. The internal resistance, the Seebeck coefficient and the efficiency are determined.

Equipment

Thermogenerator	04366.00	1
Flow-through heat exchanger	04366.01	2
Heat conductive paste, 50 g	03747.00	1
Connection box	06030.23	1
Rheostat, 33 Ohm, 3.1 A	06112.02	1
Voltmeter, 0.3-300 VDC, 10-300 VAC	07035.00	1
Ammeter 1/5 A DC	07038.00	1
Stopwatch, digital, 1/100 sec.	03071.01	1
Immersion thermostat A100	46994.93	1
Accessory set for A100	46994.02	1
Bath for thermostat, Makrolon	08487.02	1
Lab thermometer, -10...+100C	38056.00	1
Thermometer, -10...+ 50 C	38033.00	1
PEK wire resistor 2.7 Ohm	39104.72	1

Rubber tubing, i.d. 7 mm	39282.00	4
Connecting cord, 500 mm, red	07361.01	3
Connecting cord, 500 mm, blue	07361.04	2

Problems

1. To measure no-load voltage U_0 and short-circuit current I_S at different temperature differences and to determine the Seebeck coefficient.
2. To measure current and voltage at a constant temperature difference but with different load resistors, and to determine the internal resistance R_i from the measured values.
3. To determine the efficiency of energy conversion, from the quantity of heat consumed and the electrical energy produced per unit time.

Set-up and procedure

The experiment is set up as shown in Fig. 1.

1. Secure flow-type heat exchangers to each side of the thermogenerator. Fill the cold side with tap water and set the temperature of the hot side on the thermostat. The two temperatures are measured using the holes in the thermogenerator provided for the purpose. The short-circuit current and the no-load voltage are measured directly, the internal resistance of the measuring equipment being disregarded.

Fig. 1: Experimental set-up for measuring no-load voltage and short-circuit current as a function of temperature difference.

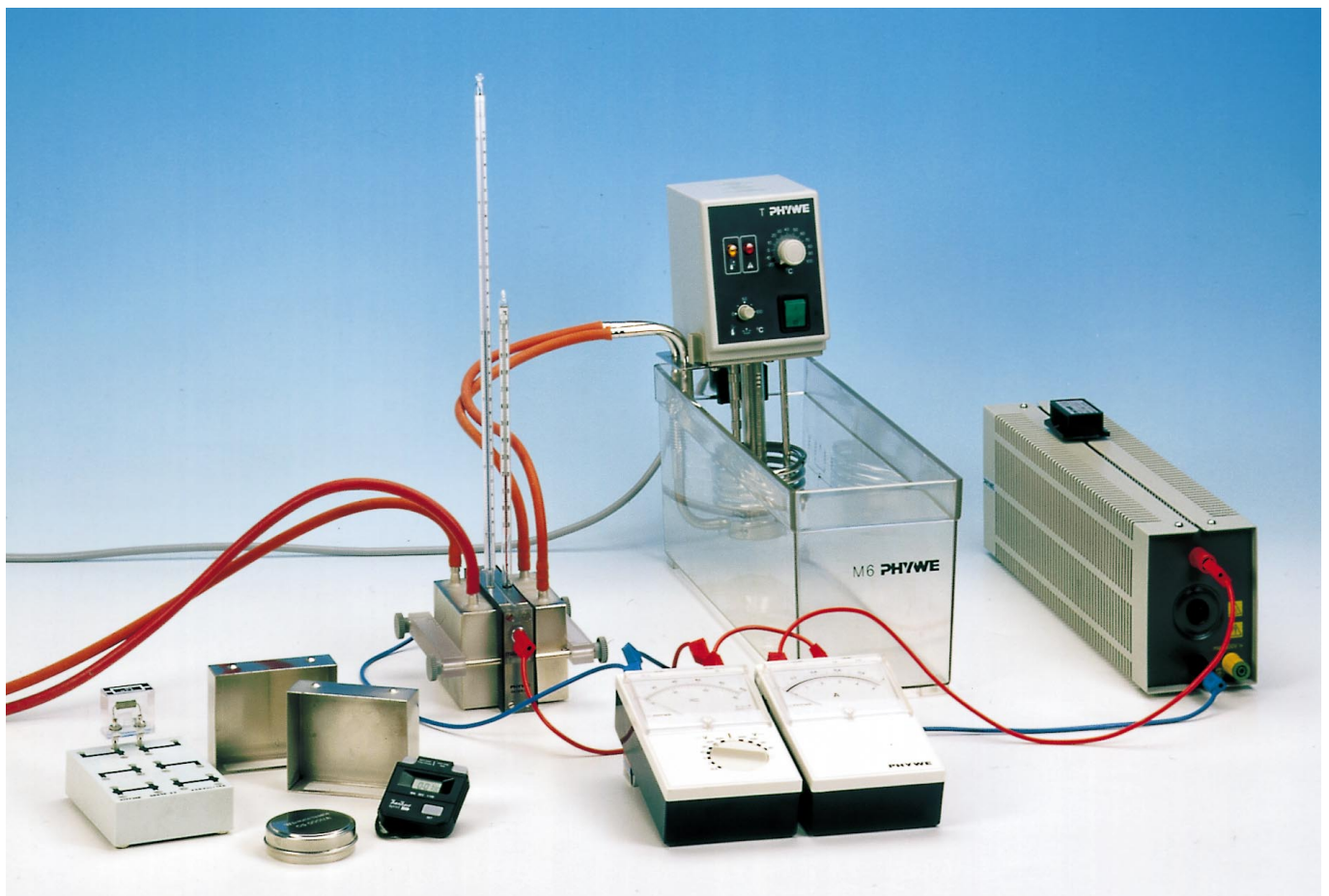

Fig. 2: Construction of a semiconductor Seebeck element.
Several elements are generally connected electrically in series and thermally in parallel.

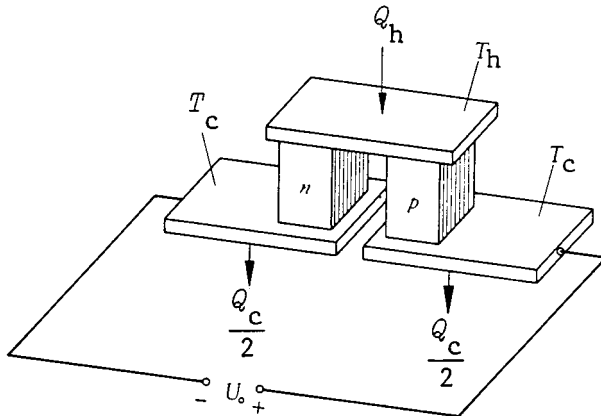
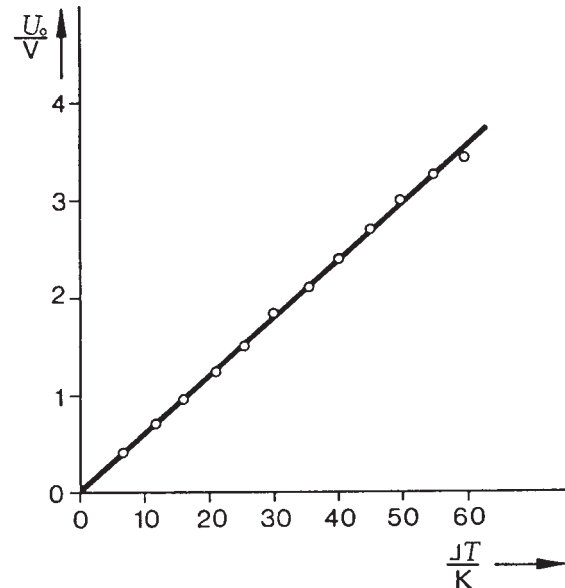

Fig. 3: No-load voltage as a function of the temperature difference.



2. Connect rheostat R_{ext} to the thermogenerator at a constant average temperature difference. Measure the current and voltage at different settings and plot the results on a graph.

3. Remove the heat exchanger which was connected to the thermostat and put a water bath brim-full of boiling water in its place. Measure the temperature of the hot side $T_h = f(t)$ and of the cold side $T_c = f(t)$ as a function of time. Measure the current and the voltage across an external resistance of approximately the same value as the internal resistance.

Theory and evaluation

If a temperature drop is created along a current-free branch of a conductor made up of different materials, heat flows from the warmer region to the cooler one. The charge carriers which take part in this transfer of heat are unevenly distributed along the conductor. An internal field strength is set up, which can be shown to be the e.m.f. U_o at the open ends of the conductor (Seebeck effect).

The voltage level depends on the temperature difference and on the materials used. To a first approximation, the voltage may be written:

$$U_o = \alpha_{1,2}(T_h - T_c) = \alpha_{1,2} \Delta T$$

where $\alpha_{1,2}$ is the Seebeck coefficient of the combination of materials used, T_h is the temperature of the hot side and T_c the temperature of the cold side.

1. Applying the regression expression

$$U_o = a + b \Delta T$$

to the measured values in Fig. 3, we obtain

$$b = 0.0587 \frac{\text{V}}{\text{K}}$$

with the standard error

$$s_b = 0.0006 \frac{\text{V}}{\text{K}}$$

The thermogenerator consists of 142 elements connected in series. The Seebeck coefficient of the semiconductor combination used is therefore

$$\alpha_{1,2} = 4.13 \cdot 10^{-4} \frac{\text{V}}{\text{K}}$$

with the standard error

$$s_{\alpha_{1,2}} = 4.04 \cdot 10^{-4} \frac{\text{V}}{\text{K}}$$

As the short-circuit also increases linearly with the temperature, the internal resistance of the thermogenerator is constant in the temperature range considered.

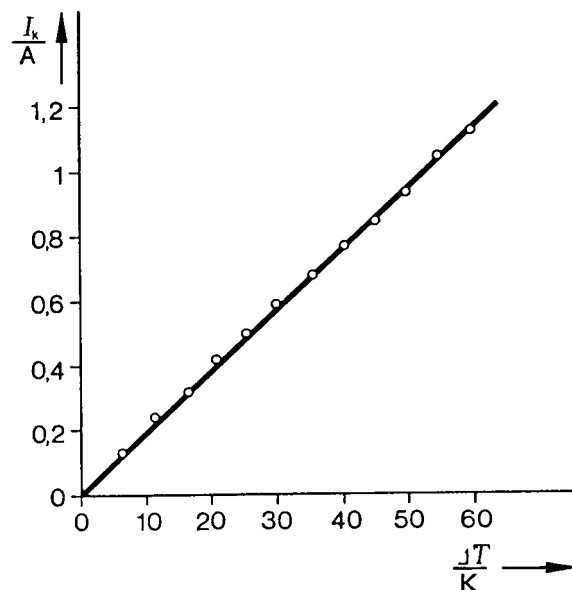
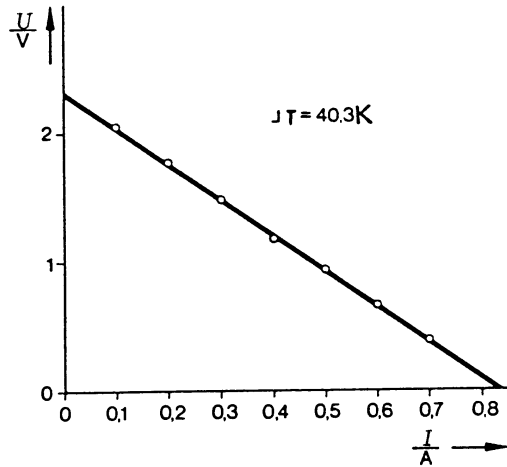

Fig. 4: Short-circuit current as a function of the temperature difference.

Fig. 5: Terminal voltage as a function of the current strength of a constant temperature difference.



2. Applying the regression expression $U = a + b I$ to the measured values from Fig. 5 we obtain

$$a = U_0 = 2.34 \text{ V}$$

$$s_a = s_{U_0} = 0.01 \text{ V}$$

and $|b| = R_i = 2.80 \Omega$

$$s_b = s_{R_i} = 0.02 \Omega.$$

and the short circuit current

$$I_s = \frac{U_0}{R_i} = 0.84 \text{ A}$$

with $s_{I_s} = 0.01 \text{ A}$

From Fig. 6 we determine the slope of the (descending) curve at one point by drawing a tangent or by linear regression.

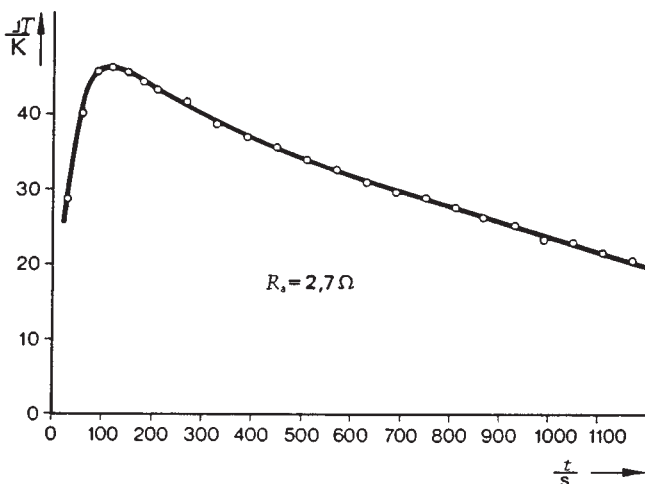
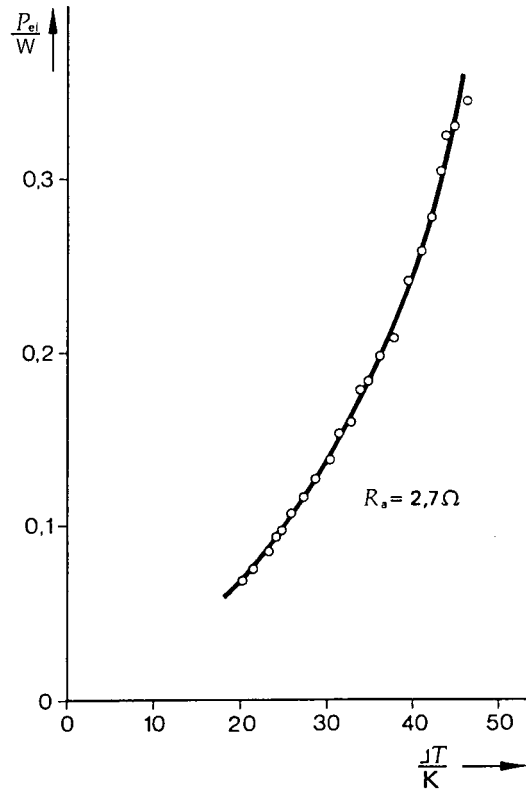

Fig. 6: Temperature difference as a function of time.

Fig. 7: Electrical power generated as a function of the temperature difference.



At a temperature difference ΔT of 40 K we obtain the following for the nearest measured values, using the regression expression $\Delta T = a + b t$:

$$b = \frac{d \Delta T}{dt} = -0.0361 \frac{\text{K}}{\text{s}}$$

We can thus work out the quantity of heat Q flowing through the generator in unit time in accordance with

$$\frac{dQ}{dt} = P_{th.} = C \cdot \frac{d \Delta T}{dt}$$

As the mass of water $m_w = 0.194 \text{ kg}$ and the specific heat capacity of water

$$c_w = 4182 \frac{\text{J}}{\text{kg K}}$$

we obtain

$$C = m_w \cdot c_w = 811 \frac{\text{J}}{\text{K}}$$

so that

$$P_{th.} = 29.3 \frac{\text{J}}{\text{s}}$$

The electrical power, measured at constant load, $P_{el.}$, can be obtained from Fig. 7. For a temperature difference $\Delta T = 40 \text{ K}$ we obtain $P_{el.} = 0.25 \text{ W}$, so that the efficiency

$$\eta = \frac{P_{el.}}{P_{th.}} = 0.009 \text{ or } 0.9\%$$